

TangibleGrid: Tangible Web Layout Design for Blind Users

Jiasheng Li
jsli@umd.edu
University of Maryland
College Park, Maryland, USA

Zeyu Yan
zeyuy@umd.edu
University of Maryland
College Park, Maryland, USA

Ebrima Jarjue
ebjarjue@terpmail.umd.edu
University of Maryland
College Park, Maryland, USA

Ashrith Shetty
ashrith@terpmail.umd.edu
University of Maryland
College Park, Maryland, USA

Huaishu Peng
huaishu@cs.umd.edu
University of Maryland
College Park, Maryland, USA

ABSTRACT

We present TangibleGrid, a novel device that allows blind users to understand and design the layout of a web page with real-time tangible feedback. We conducted semi-structured interviews and a series of co-design sessions with blind users to elicit insights that guided the design of TangibleGrid. Our final prototype contains shape-changing brackets representing the web elements and a baseboard representing the web page canvas. Blind users can design a web page layout through creating and editing web elements by snapping or adjusting tangible brackets on top of the baseboard. The baseboard senses the brackets' type, size, and location, verbalizes the information, and renders the web page on the client browser. Through a formative user study, we found that blind users could understand a web page layout through TangibleGrid. They were also able to design a new web layout from scratch without the help of sighted people.

CCS CONCEPTS

• **Human-centered computing** → **Accessibility systems and tools.**

KEYWORDS

Accessible web design, tactile feedback, tangible user interface, visual impairment, accessibility

ACM Reference Format:

Jiasheng Li, Zeyu Yan, Ebrima Jarjue, Ashrith Shetty, and Huaishu Peng. 2022. TangibleGrid: Tangible Web Layout Design for Blind Users. In *The 35th Annual ACM Symposium on User Interface Software and Technology (UIST '22)*, October 29–November 2, 2022, Bend, OR, USA. ACM, New York, NY, USA, 12 pages. <https://doi.org/10.1145/3526113.3545627>

1 INTRODUCTION

Assistive technologies have greatly changed the lives of blind and visually impaired people. Beyond Internet consumers, blind users

Permission to make digital or hard copies of all or part of this work for personal or classroom use is granted without fee provided that copies are not made or distributed for profit or commercial advantage and that copies bear this notice and the full citation on the first page. Copyrights for components of this work owned by others than ACM must be honored. Abstracting with credit is permitted. To copy otherwise, or republish, to post on servers or to redistribute to lists, requires prior specific permission and/or a fee. Request permissions from permissions@acm.org.
UIST '22, October 29–November 2, 2022, Bend, OR, USA

© 2022 Association for Computing Machinery.
ACM ISBN 978-1-4503-9320-1/22/10...\$15.00
<https://doi.org/10.1145/3526113.3545627>

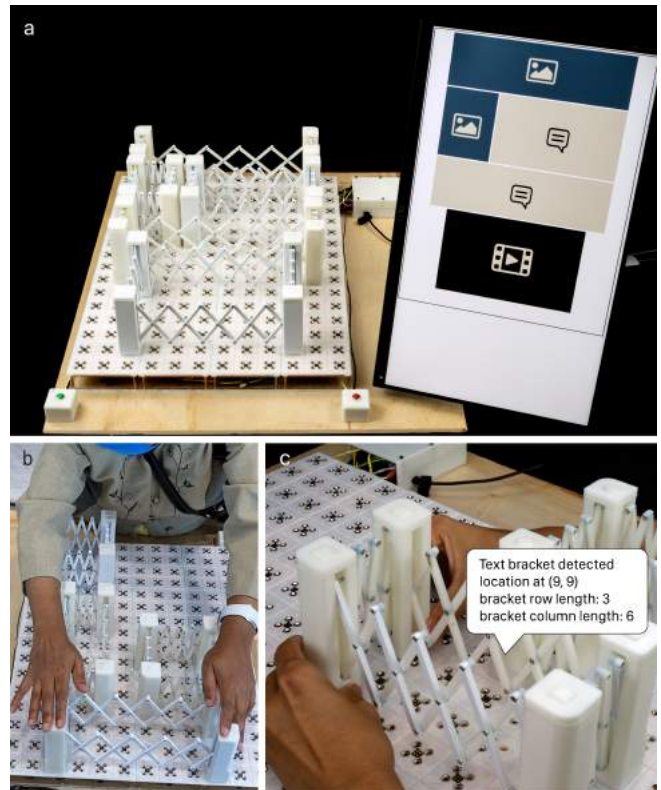

Figure 1: TangibleGrid overview. a) The complete system of Tangible grid; b) a participant is exploring a web page layout; c) designing a new layout by resizing and placing a bracket to the baseboard.

are now able to share stories and life events on social media sites such as YouTube [21] and Instagram [38]; some blind users have also created and maintained their own web pages for blogging and knowledge sharing [18, 33]. Indeed, the stories and daily experiences of the blind media influencers have become an important source of support to the blind community. Mastering skills like building web pages has also led to new employment opportunities for blind and visually impaired people [9, 10].

Unfortunately, creating a web page is still challenging for many blind users despite the strong need for it [33, 37]. For one, web

page design often requires blind developers to code in HTML and CSS, which has a series of accessibility challenges [33]. Responding to these issues, researchers have proposed workshops and online courses that help blind users learn web programming using screen readers [34, 60]. Assistive programming tools such as CodeTalk [50] and StructJumper [6] can also help blind users understand the semantic meaning of code structures. While these efforts support blind users in writing a program or coding web page content, a second barrier is preventing many blind users from having their own web page. Few accessible tools can help blind users understand and design the graphical layout of a web page [53], where visual semantics such as the size, shape, and location of the content matter [33, 37, 48].

Recently, researchers have started exploring ways of allowing blind users to understand and edit graphical layouts on a screen. Potluri *et al.* [49] showcase a prototype that allows blind developers to modify a web page layout by coding in the IDE or using gestures on a touchscreen. Li *et al.* [37] present a multimodal tool that allows blind users to understand a web page layout with tactile print-outs and change it using a self-voicing tablet application. While their tool offers tactile feedback for web page layout editing, users must reprint a new layout with swell paper every time a change is made. The multiple-step editing process is not as smooth as the direct manipulation approach [27] that sighted users experience.

In this paper, we present TangibleGrid, a working prototype that allows blind users to understand and design the layout of a web page with real-time tangible feedback. With TangibleGrid, a blind user can place multiple visual elements, such as a textbox, a figure, or a video on a web page canvas by directly snapping the corresponding tangible brackets onto a custom baseboard. (Figure 1a). Each type of bracket has a unique tactile pattern on its top that blind users can understand. The bracket can also be resized while remaining as a rectangle so that a blind user can alter the web page layout by directly resizing or relocating these brackets. Changes are registered to the baseboard immediately so that the brackets' location, size, and type can be read to the user in real-time. An HTML web page will also be rendered automatically to the user.

TangibleGrid is the first tool that allows blind users to 1) understand the visual layout of a web page and 2) edit the design independently and with instantaneous feedback. The development of TangibleGrid went through an iterative design process. We started by conducting semi-structured interviews with six blind users to understand their challenges when browsing and/or creating web pages, and the potential solutions that have been explored (if any). We then went through three rounds of co-design sessions with a blind developer in our team, to evaluate various physical probes and artifacts, each emphasizing a specific design perspective that may help the layout design and creation. The final prototype was evaluated in-person with ten blind participants through a formative user study. All blind participants were able to understand the layout of an existing web page through TangibleGrid. They could also create a web page layout with the prototype, despite some having no previous experience in web page design and editing.

In summary, our paper contributes: 1) the investigation of the practices, challenges, and opportunities that blind users have concerning web page layout design and understanding; 2) a working prototype that supports the creation of a web page layout with

real-time tangible feedback; 3) a formative user study to evaluate the tool.

2 RELATED WORK

Our work builds upon the notions of accessible web programming, interactive tactile graphics, accessible tangible user interfaces, and web layout design tools.

2.1 Accessible Web Programming

Several studies [2, 3, 42] have uncovered the numerous challenges that blind users face when programming. For example, commercial IDEs such as Visual Studio Code [43] and Apple Xcode [17] lack sufficient accessible features; screen readers such as JAWS and NVDA also have compatibility issues with these programming environments, making it difficult for blind programmers to navigate through lines of code.

To address the accessibility issues, several IDE plugins are developed to support code navigation and debugging [6, 50, 59]. Workshops, courses, and online resources are also developed to help blind developers or students write programs or get familiar with the IDE features [22, 30, 32, 34, 60].

Although much effort has been made to support accessible programming in general, web programming renders new challenges on top of the accessible programming issue [33, 48, 53]. As the output of the code, the web page mainly contains visual information; blind developers have no sufficient tools to access the graphic layout of the design and thus, have difficulties in understanding the web page created by themselves. TangibleGrid hopes to address this issue by offering tangible feedback on a web page layout.

2.2 Interactive Tactile Graphics

For blind users, tactile graphics are essential to learning and exploring graphical information such as maps or bar charts. Traditionally, tactile graphics are made with a Braille embosser or printed on swell paper; therefore, the presented information is static and often with a limited amount due to the restrict paper space [13, 26, 29]. This makes it challenging to provide sufficient information without overly complicating the printed layout [62]. To overcome these limitations, researchers have proposed to offer additional information using sound [7, 44] and haptic [66], sometimes referred as interactive tactile graphics [39]. For example, Tactile Graphics Helper [24], Talking TMAP [44], and Talking Tactile Tablet [36] can generate different levels of audio descriptions based on the points of interest that a user touches. These audio annotations allow what could be verbose in printing to be spoken directly to the user.

In recent years, the democratization of fabrication technology, such as 3D printing, has extended interactive tactile graphics beyond 2D graphics. Researchers have used various 3D printed models to teach blind users the concept of visualization [31], to allow them to recognize 3D models [55, 56], to create graphic books for blind children [35], or to make the tactile interfaces of appliances accessible [25]. Most aforementioned printed artifacts have supporting systems or audio tags to speak the information to blind users, but these 3D printed artifacts remain mostly static and less interactive. In our work, we also utilized 3D printing technology to make the TangibleGrid prototype. Rather than being static, our tangible

brackets can be dynamically changed by blind users to meet their design needs.

2.3 Accessible Tangible User Interfaces

Interactive tactile graphics provide scaffolding for blind users to understand a wide range of graphical information, but they often lack sufficient features to be responsive in a haptic manner. Recently, HCI research has explored the use of tangible user interfaces [28] to make tactile graphics dynamic and reactive [41, 54]. For example, pin-based displays are common approaches to represent information dynamically [4, 51, 65]. Systems such as HyperBraille [65] can render graphical information, such as a web page, onto a matrix of raised pixels. ShapeCAD [58] further extends the concept to support 3D creation. Although dynamic and responsive, one common challenge for these pin-based displays is the high cost. A half-page size, pin-based display can cost more than 50,000 USD, which is not affordable to the majority.

Another type of accessible tangible user interface is based on the metaphor of an active tabletop. For example, Tangible Reels [19] combines a tabletop display and a set of retractable tangible reels to allow visually impaired users to construct tangible maps. Following step-by-step audio instructions, blind users can replicate a line-dot map with the set of tangibles and then use the creation to understand the specific information related to the reels and nodes. Tangible Desktop [8] further explores the concept by replacing the auditory channel with a set of tangible gadgets, which allows novice screen reader users to have a faster task completion time than audio-only systems. Mobile robots of various forms have also been used as part of the tangible tabletop interfaces to actively guide the user's attention. For example, Cellulo [47] allows a blind user to hold it in their hands and then actively guides their hand movement for kinesthetic learning or to display autonomous motion. FluxMarker [61] uses a flat electromagnetic baseboard to mobilize small magnets, which act as dynamic tactile markers to show a blind user certain points of interest. TangibleGrid takes inspiration from the aforementioned accessible tangible user interfaces. We convert an HTML canvas into a blank tangible baseboard that is similar to the tabletop metaphor. However, our tool's tactile and haptic features, including the shape-changing tangible brackets and the magnetic snapping method, are specifically made to meet the need for a web layout design tool.

2.4 Web Layout Design Tools for Blind Users

For sighted people, there is a great amount of research that focuses on web layout recommendations or graphical layout design [16, 40, 45, 63, 64]. However, the studies that support blind users to understand or design a web page layout are insufficient, with a few exceptions. Potluri *et al.* [49] develop a prototype that allows blind programmers to edit a web page layout by combining coding with gestures on a touchscreen. Tactile Sheets [5] discusses the concept of overlaying laser-cut paper on top of a touchscreen device to facilitate the understanding of a digital document's layout and logical structure. Li *et al.* [37] apply the concept to web page layout design with a working prototype. Their system requires a user to put a tactile print-out of a web page template on top of a self-voicing tablet. The user can then feel the web page layout and indicate the

modifications they hope to make. The updated layout will be printed out on a different piece of swell paper and then overlaid on the touch screen. The user is then able to confirm the design or work on further editing. One challenge for overlaying printed layouts on a touchscreen device is that the feedback is not synchronous. There is a time delay for each design iteration that requires the user to print a new layout and align it to the touchscreen.

In our work, we share the same promise to support web page layout design by blind users. Unlike previous work, TangibleGrid allows blind users to understand and design a web layout in real-time; the user will be able to hear the audio description and confirm the design with their hands every time they add or edit an HTML element on the canvas.

3 UNDERSTANDING THE CHALLENGE

To understand the current practices and needs for accessible web layout design tools, we conducted semi-structured interviews [1] with six blind users, including one co-author of our paper, who had previously studied web programming at the college level, and maintained his own web page. The demographic information of the rest of the participants is presented in Table 1 as P1 - P5. Among all participants for the interviews, three have self-reported web design or programming experience before or after losing sight; three have no relevant experience. We hoped to understand the challenges that people with different web design literacy levels encounter. Each interview lasted 40 min to 1 hour. We present key findings from the interviews, which, together with insights from previous literature, guide the design of TangibleGrid.

3.1 Findings

3.1.1 Audio is primary. Participants affirmed that screen readers were the primary assistive tools for most digital activities. They used screen readers to consume web content on PC and phones; some participants also reported using screen readers for productive tools such as PowerPoint and WordPress. Participants mentioned that screen readers were helpful in putting text information in slides or a web page template. They were able to identify empty text boxes with voice guidance. However, all participants mentioned that the voice support could only help them understand what was on the screen (*i.e.*, text box), but not where.

3.1.2 No accessible web page layout information. Missing support for web layout understanding was one theme that came across all participants with or without relevant experience. Participants with web programming experience struggled with understanding spatial information, even if they generated the content. As described by one participant: "...I cannot do anything that is graphical ... I can, you know, do my HTML, CSS, and put all the colors the way I learned it. But I don't know what is on the screen". P3 talked about their experience of using templates on WordPress and Medium.com. "...I can put the content in them with the help of screen readers, but I don't know how they are presented on a web page, and I always have to ask a sighted friend to confirm the result". Other participants without web design experience reported their practice of how they consume web information. To them, missing location information of web content was also frustrating. P2 said, "I know there is an address bar on the top of the screen, maybe, I think. However, I don't know where

everything is on a web page. I just hear them as the computer speaks but that doesn't tell me where exactly on the page ... I have no sense of spatial information where the things are".

3.1.3 Desire for autonomy. Three participants discussed their willingness to be independent. One theme that participants repeatedly brought up was the reliance on sighted people to “confirm the design” or to help fix the errors when programming (e.g. counting indentations).

3.2 Design Implications

The interview confirmed the lack of support for blind users – with or without relevant experience, to understand and design the layout of a web page. From our collected semi-structured interviews, we came up with three design considerations.

- (1) *Direct representation of the graphical layout.* As suggested in the interview, blind users have no direct way of knowing how web elements are graphically presented on the screen. While screen readers can partially read the context, they cannot adequately describe information such as the location, size, or type of web content. Inspired by previous work on accessible tangible interfaces [41, 54, 57], we propose to use tangibles to represent critical visual elements of a web page layout. Ideally, the tangibles should be easy to understand and operate and can offer support to blind programmers and novices who share an interest in creating personal web pages.
- (2) *Supporting layout design with autonomy.* As previously noted, blind users prefer to reduce their reliance on sighted helpers when possible. The web page design can also be personal and may require frequent changes. Thus, we hope our tool can enable blind users to generate the page layout individually.
- (3) *Multimodal feedback.* As blind users universally rely on voice feedback, it should be combined with haptics to provide a detailed description.

4 TANGIBLEGRID

Informed by the design criteria, we developed TangibleGrid, a novel device that allows blind users to understand and design the layout of a web page with real-time tangible feedback. Figure 2 shows the main design concept of TangibleGrid. The key is to use custom tangibles to represent the graphical layout of a web page. With each tangible representing the main information block of a web page (e.g. a text box or a figure), TangibleGrid can allow blind users to understand the overall structure of a web page by scanning across the device with their hands. As these tangibles are also resizable and relocatable, blind users can design the entire web page layout by themselves without constantly seeking help from sighted companions. The audio support of TangibleGrid will verbalize each tangible’s location, size, and type, providing blind users real-time feedback on the creation.

Note that since the overarching goal of the tool is to provide a tangible approach to understanding and designing the layout of a web page, we do not intend to physicalize all web page details. In fact, as discussed in [20], simplification is mandatory for tactile exploration. In the case of web layout, we focus on representing the location, size, and types of major web page building blocks. Other

information is intentionally omitted in this implementation but can potentially be added as a separate process, which we discuss in Section 6.3.



Figure 2: Design concept.

4.1 Design Process

The design of TangibleGrid is in deep collaboration with Ebrima, the third author of our paper, who is a blind student and researcher in the field of accessibility and, as noted previously, maintains his own web pages. We went through three co-design activities to explore proper tangible mechanisms, tactile patterns, as well as audio feedback that are accessible. Below we briefly describe the three co-design activities and the lessons we learned from them.

4.1.1 Co-design #1. The first round of co-design activity mainly focused on exploring how tangible mechanisms can represent HTML visual elements. As these visual elements are digital bounding boxes of different sizes, our design intuitive was to use resizable rectangle brackets to represent these elements. Specifically, we 3D printed two set of resizable brackets, using elastic rubber bands and telescopic bars as the resizing mechanism, as in Figure 3a and b. The rubber version can resume its initial shape when not used; the telescopic version has rigid linkages to maintain the rectangle shape. Two additional baseboard designs were also prepared to represent the web page canvas as in Figure 3f and g, with raised grid edges and extruded pillars as the brackets anchoring mechanisms.

During the co-design activity, the two bracket probes were presented to Ebrima one by one. For each bracket, Ebrima was instructed to first extend or minimize it multiple times, then place it on the baseboards and at different locations. Throughout the design session, Ebrima employed the think-aloud method [11, 46] and talked about if any features of these designs helped or prevented him from 1) understanding the spatial information and 2) moving the bracket from one place to another.

Findings: Ebrima confirmed that he could understand and change the location and size of the two bracket probes, indicating that

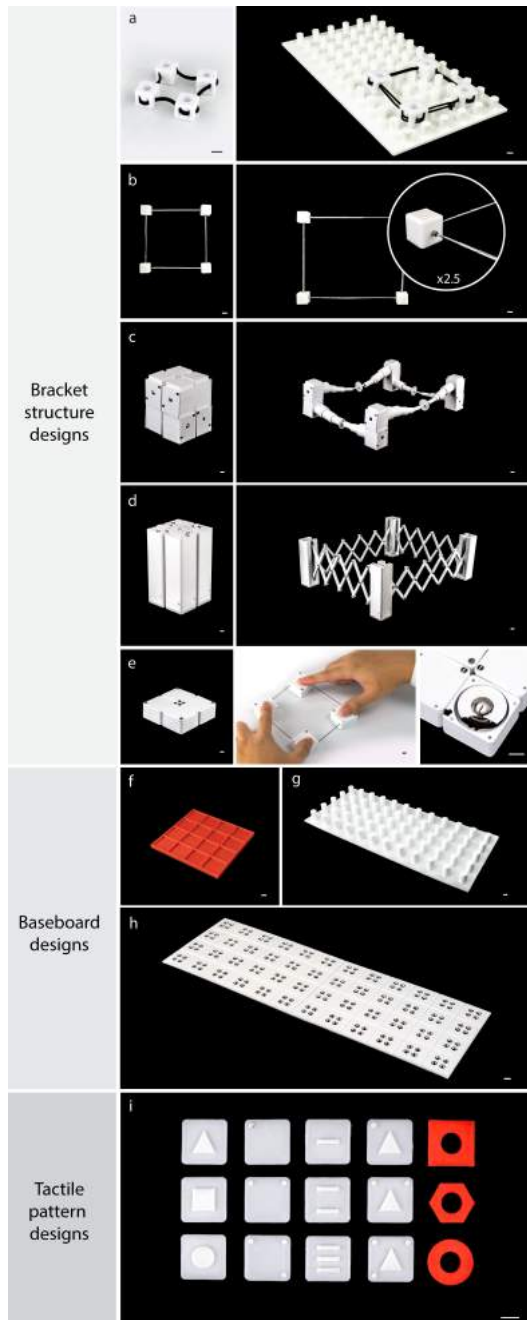

Figure 3: Design probes for the co-design sessions. Figure a) - e) are bracket designs with different connecting methods, including rubber, one-directional telescopic extension, two-directional telescopic extension, scissored linkage, and spring-loaded strings; f) - h) are baseboard designs with raised borders, extended pillars, and concave grooves with magnets; i) has five different tactile pattern designs, with extruded shapes, Braille-like dots, extruded bars, extruded bars with dots, and side-raised indicators.

representing the web elements with tangible artifacts is a feasible approach. Specifically, Ebrima preferred the bracket design with telescopic structure over the rubber band one, citing that the former could provide a rigid feeling and made him feel the edge of the bracket. Ebrima also commented that putting these brackets onto the two baseboards was challenging since he needed to align all four corners of the bracket to the baseboard pillars or grids for a successful placement. However, Ebrima liked the raised grid feature (Figure 3f), as these raised edges could allow him to quickly count and find the locations.

The feedback from Ebrima informed the rest of the probes design, which were examined in the second design session.

4.1.2 Co-design #2. In the second round of the design activity, we presented three additional bracket designs: a two-direction telescopic mechanism (Figure 3c) as an upgrade to the original telescopic probe, a scissored linkage structure (Figure 3d), and a spring-loaded string structure (Figure 3e), inspired by Tangible Reels [19]. We also presented a third baseboard design as in Figure 3h. The design was inspired by the raised edge feature as in Figure 3f, but with engraved grooves and magnets to assist alignment.

Additionally, we prepared five types of tactile patterns as markers to represent different web element types, such as text, figure, and video. The design rationale was to use distinguishable shape features to differentiate web element types. From left to right of the Figure 3i, the first set of patterns aimed to use extruded shapes as tactile markers; the second and third sets used Braille-inspired dots, and Directional Tactile Paving-inspired bars as tactile markers; the fourth combined set one and two to explore if the combination of different tactile features were recognizable; and the fifth set had raised side edges that explored whether a blind user could recognize the shape by directly grabbing the brackets.

Like before, Ebrima was instructed to test the placement of the bracket probes, feel the tactile patterns, and describe the potential issues of each design.

Findings: Ebrima confirmed that the scissored linkage bracket (Figure 3d) was the best among all bracket candidates, as the scissored linkage was the easiest for him to resize due to its rigidity. The tall height of the design, which we originally thought was a limitation, turned out to be a good feature as it provided a sizeable graspable area for Ebrima to hold the bracket. The new baseboard was also applaudable. "I like the magnet baseboard. First, it's all flat, feels like an empty HTML file. Second, the magnet force makes bracket snapping feeling good". Among the five sets of tactile patterns, Ebrima confirmed that both set 1 and 3 could be recognized easily. The patterns were hard to recognize for set 2 or 4 due to the smaller dot size and the closer distance between patterns. Set 5 was also hard to distinguish. Thus, our final design, as we will introduce in Section 4.2, used both set 1 and 3 as the tactile patterns.

4.1.3 Co-design #3. In the last session, we focused on potential voice feedback that can assist the web layout design. A set of audio files were prepared, with three different speed rates, 120, 170, and 220 wpm, as suggested by the previous literature [12, 23], and six different content orders, with the type, dimension, and size being first, respectively. Following the Wizard of Oz method [15], we played these audio files to simulate the auto-generated audio instructions when Embria placed a bracket on the baseboard. We

then asked Ebrima to repeat each audio content as accurately as possible.

Findings: Ebrima could repeat the content at all speeds, with 170 wpm being the most comfortable. Regarding the content order, Ebrima commented that the bracket type was most important to him, followed by location and size. Hence the speed and order were chosen for the final design. Through the co-design session, we also learned that blind users had to be able to hear a piece of information repeatedly. For example, during the co-design session, we only played the audio description of a bracket placement once. Ebrima pointed out that he might need to hear the description for confirmation repeatedly. He also pointed out that he may hope to know where the previous brackets are when designing a web layout with several brackets. The information on the current bracket solely would not be sufficient. These feedbacks were incorporated into the final system design.

4.2 System Overview

The three rounds of co-design sessions offered us a plethora of insights to effectively translate and tangibly present visual layout, which contributed to our final prototype. We now detail the main features and the implementation of the tool.

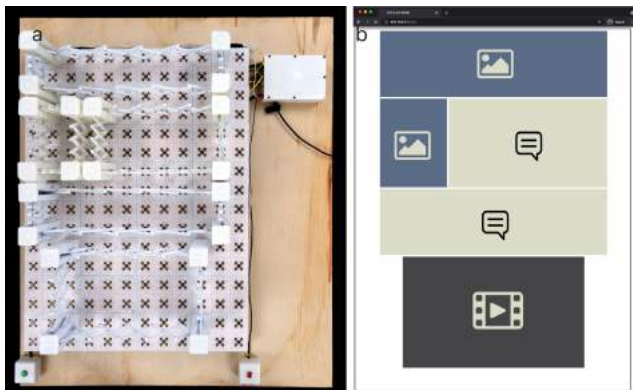

Figure 4: TangibleGrid overview. a) A set of brackets with different types being placed on the baseboard. b) The corresponding web page layout is rendered in a browser.

Figure 4 shows the TangibleGrid tool. TangibleGrid composes a physical baseboard and a set of shape-changing tangible brackets representing three essential web page elements: text, figure, and video clip. The brackets are constrained to the shape of rectangles to reflect the rectangular shape of a web element. When a blind user brings a bracket of a particular content type, say an image element, close to the board, it will firmly snap to the baseboard and self-aligned to the grids. The physical baseboard senses its type, location, and size and immediately speaks this information out to the user. The corresponding HTML element is simultaneously rendered on the screen with a content template. The user can adjust the size or location of the web element by pulling or pushing the corners of the corresponding bracket. The updated information will be vocalized, and the screen will be updated automatically. If the user hopes to repeat the last bracket's information, they can

press the physical button at the bottom right of the baseboard. The user can press the physical button left of the baseboard to hear the information about all existing brackets.

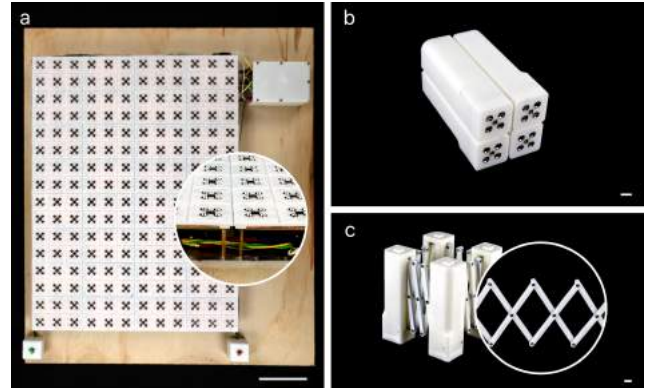

Figure 5: Final prototype. a) The baseboard (scale bar: 50 mm). b) The bracket with magnet base and pogo pin connectors (scale bar: 10 mm). c) The scissored linkage mechanism (scale bar: 10 mm).

4.3 Hardware

As shown in Figure 5a, the baseboard is 420 mm × 560 mm with a grid of 12 columns and 16 rows. The 12-column design follows the W3C guideline [14]. The 16 rows ensure the baseboard has enough space if the user would like to design a vertical web page layout beyond a one-screen asset.

The grid is engraved with 'V' shape grooves. Four 6.35 mm diameter countersunk ring magnets are evenly distributed at the center of each grid cell with a 3 mm space in between. At the very center of every four magnets, a 2×2 female pogo pin connector is placed. Thus, a total of 192 female pogo pin connectors are placed across the baseboard. These connectors will connect to the brackets electrically when in contact.

The final bracket (Figure 5b) has four corner pillars, each with a rounded rectangle square base ($r = 3$ mm, side length = 30 mm) and a height of 113 mm. As suggested by the co-design activities, we employ the scissored linkage to ensure solid, smooth and long-range extension. Each of the scissored structure has connection links with a size of 91 mm × 5 mm × 4 mm. They are assembled with M2 bolts and nuts at each revolving joint. The bracket has a maximum extension of 420 mm and can be fully folded (Figure 5c). Each bracket is equipped with a specific set of tactile markers at its top to indicate the web element's type. To ensure the bracket type is distinguishable in the software, each corner pillar is inserted with a corresponding resistor to its bottom. The two ends of the resistor are soldered to the two diagonal pins of a 2×2 spring-load male pogo pin connectors that match the ones on the baseboard (Figure 6). Using the 2×2 pin connectors ensures that the resistors in the bracket corners can always connect to the baseboard regardless of the bracket placement orientation.

4.3.1 Electronics. To recognize the brackets on the baseboard, we implement a key switch matrix circuit (Figure 7). As each bracket

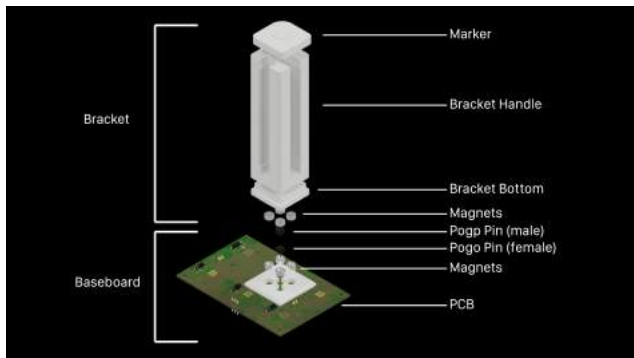

Figure 6: Illustration of the bracket-baseboard connection.

has four corners, and all corners have resistors of the same value, they all act as switches at the intersecting point of the baseboard grid. When a user places a bracket on the baseboard, the male pogo pin connectors of the bracket is in contact with the female ones on the baseboard, which complete the circuit.

The scanning algorithm for the key matrix activates one row at a time to detect if any of the column switches are closed. Multiple closed switches will cause an error known as ghosting or masking, *i.e.*, registering false switch status and failing to detect when a switch isn't closed anymore. This can be rectified by adding a switching diode in series to the resistor within each switch. In our case, we use diode 1N4001 to prevent ghosting and faulty readings.

We adopt three resistor values to represent different types of the brackets. The calculation of the resistance for each placed bracket is performed with a voltage divider circuit. A reference resistor of 1k ohms is used per column to measure resistance values between 180 ohms and 5.5k ohms, with a measurement accuracy of 2.5%. An Arduino 2560 is used to detect the resistance values of all placed brackets.

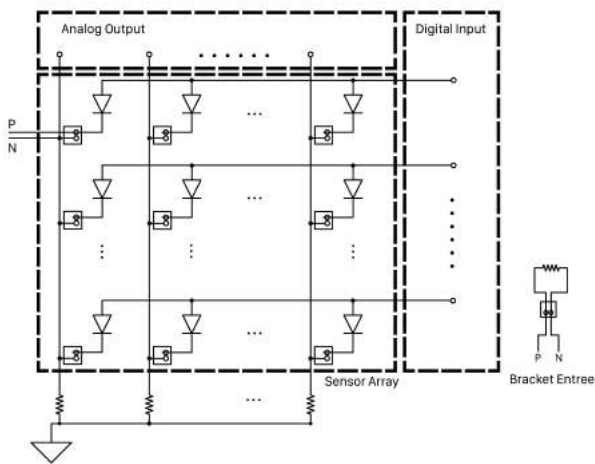

Figure 7: key switch matrix circuit.

4.4 Software

Our software application runs on Flask [52], a minimal web framework in Python. The main features of the software are to render the web page layout on the screen and generate audio feedback for the blind user in real time. To render the layout, the software contains a pre-defined web canvas file with the size of 1560 px × 2080 px. When a new bracket placement is detected by the Arduino, the information is sent to the host software where the web canvas updates the rendering automatically. Meanwhile, the information is also passed to a text-to-speech engine, which then verbalizes the bracket's type, location, and size.

5 USER STUDY

We conducted a formative user study to evaluate how the components of TangibleGrid (*e.g.*, tangible brackets, physical baseboard, audio feedback) perform in enabling blind people to understand and design a web page layout.

5.1 Participants and Apparatus

We recruited 10 participants (6 female, 4 male, age 32-67) through online postings (table 1). 6 participants were self-reported as totally blind; 4 were legally blind. All participants were familiar with screen reader technologies such as JAWS or NVDA to help them browse websites daily; one participant mentioned that a Braille display was preferred than a screen reader when browsing websites. 7 participants stated that they did not have any websites design experience; 3 participants stated that they had limited experience either in web page design or in programming.

The study apparatus included one set of TangibleGrid prototype with a 12x16 baseboard, five brackets (two text brackets, two image brackets, one video bracket), and one laptop.

5.2 Procedure and Tasks

The user study contained three stages with 90 minutes in total. All participants were compensated at a rate of \$20 per hour in gift card or cash. In the learning stage, we introduced basic web design concepts as well as the TangibleGrid prototype to the participants. In the following two stages, we asked each participant to complete two tasks: understanding an existing web page layout, and designing a web page layout from scratch. Following each task, we asked participants about their experience by answering Likert scale questions. After participants had completed all tasks, we conducted semi-structured interview to ask them about the overall experience. The study was video and audio recorded for data analysis.

5.2.1 Learning stage. After collecting participants' demographics and technology experiences, we presented our prototype to participants. Participants were asked to get familiar with the tangibles, for example, by extending or folding the brackets, or by scanning across and touching the baseboard. During the learning stage, we explained to the participants how the prototype related to the web page layout, *e.g.*, the baseboard represents a web page canvas and brackets represent web content elements. Participants could take time to familiarize themselves with TangibleGrid until they felt comfortable. We then started the task 1.

Table 1: Participants demographics.

ID	Age	Gender	Vision Level	Accessible Aids Software	Programming Skill	Web Design Experience	Education Background
P1	56	Female	Totally blind	JAWS	No	No	Bachelor
P2	46	Female	Totally blind w/ Light perception	JAWS	No	No	Master
P3	43	Female	Totally blind w/ Light perception	JAWS, Braille Display	No	Yes	Master
P4	44	Male	Legally blind	NVDA, Narrator on Windows	Yes	Yes	Ph.D.
P5	43	Male	Legally blind	Voice-over on iPhone, JAWS on Windows	Yes	Yes	Bachelor
P6	32	Female	Totally blind	Voice-over on iPhone, JAWS on Windows	No	No	Bachelor
P7	67	Male	Totally blind w/ Light perception	Voice-over on Mac	No	No	Bachelor in progress
P8	50	Male	Legally blind	JAWS	No	No	Master
P9	66	Female	Legally blind	JAWS	No	No	Master
P10	54	Female	Totally blind	Voice-over on iPhone, JAWS on Windows	No	No	Bachelor

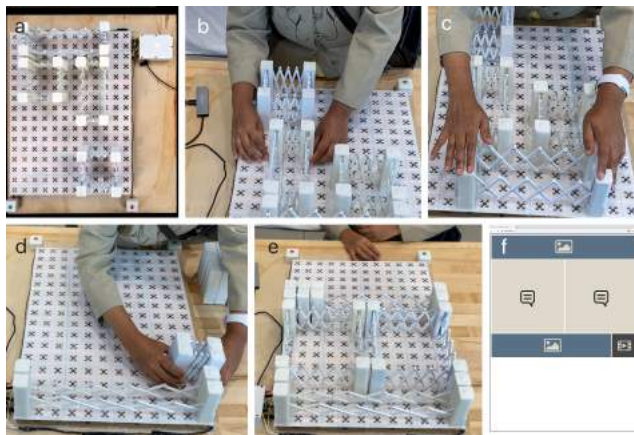

Figure 8: Two user study tasks. a) The web layout template for task 1. b) A participant is counting the size of a bracket. c) A participant is recognizing the type of a bracket. d) A participant is placing a bracket for task 2. e) The completion of the task 2. f) The rendered task 2 web page.

5.2.2 Task 1: understanding of an existing web layout. In order to evaluate how the TangibleGrid may help participants understand the web page layout, we presented participants with a pre-defined web page layout template, as is shown in Figure 8a. The template web page layout contained four brackets with different sizes and types, distributed in a spread-out manner. We asked participants to report the corresponding web page layout, including the brackets' size, location, and type. As we hoped to learn if blind participants could tangibly understand the layout by touching and counting through the brackets and baseboard grid, the audio feedback was turned off for this task.

5.2.3 Task 2: web layout design from scratch. In this task, we investigated how TangibleGrid may allow blind users to build a web page layout by themselves. Our original task plan was to have the participants design a web page layout freely. We soon learned from the pilot study that participants' designs might vary and thus were not comparable. As the goal was not to understand and task blind participants' design and creativity, we decided to ask all participants to create an identical web page layout. Figure 8e and f showed

the task web page layout. During this task, we told participants the size and location of each web element. Participants had to find the corresponding tangibles and put them on the baseboard by themselves. The audio feature was on during this task.

5.3 Results

We present our user study result in this section and summarize all the participants' findings and feedback. Note that the Likert scale questions are ranged from 1 to 7; 1 refers to strongly disagree, and 7 refers to strongly agree.

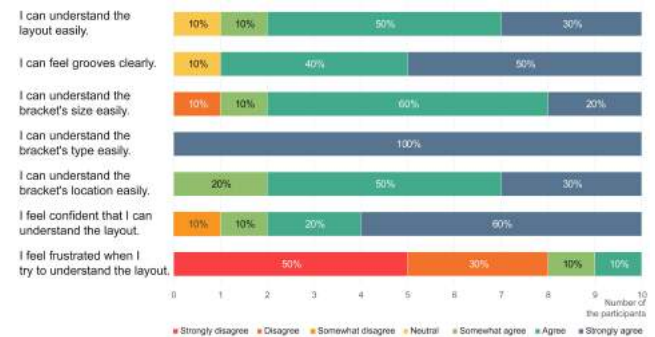

Figure 9: Self-reported ratings of web layout understanding using TangibleGrid.

5.3.1 Task 1: understanding of an existing web layout. Overall, all the participants were able to correctly report the web page layout during the task. As showed in the summarized self-reported rating (Figure 9), participants confirmed that they understood the web page layout ($M = 6.0, SD = 0.94$) with high confidence ($M = 6.2, SD = 1.3$) and low frustration ($M = 2.2, SD = 1.8$).

Key tangible features such as the bracket's type ($M = 7.0, SD = 0$), size ($M = 5.7, SD = 1.4$), and the grooves ($M = 6.3, SD = 0.95$) on the baseboard all contributed to the layout understanding. For example, P5 and P6 pointed out that the grooves were helpful in that they were obvious when scanning with hands. They could quickly sense them and count how many grooves (lines) were in front of a bracket. P9 highlighted that the bracket types and sizes could be understood by touch.

I know the location for each bracket, and how big it is, yeah, I have a sense of them, also, they are image, image, text, and then a video bracket. –P9

One interesting finding during the task was that the scissored structure of the bracket, which was mainly designed to constrain the rectangle shape during resizing, also served as a key tangible scaffold for blind participants. We observed that on several occasions, participants touched the scissored structure first and then followed through the structure to find four corners of the bracket.

Recognizing different bracket categories and identifying which four corners belong to one bracket was the first thing I did. This one is easy. I picked any of these (corners), just found one, and traced it (scissored structure) to get to the second corner. ... And I saw these two were not connected, but these two were connected. –P2

5.3.2 Task 2: web layout design from scratch. All participants were able to complete the web layout design task. The result was encouraging, given that the participants included ones with web page design experience and also many with no prior knowledge at all. As showed in Figure 10, participants stated that the prototype was easy to learn ($M = 6.5$, $SD = 0.97$) and use ($M = 5.5$, $SD = 1.7$), and that they felt confident when creating a web page layout ($M = 6.2$, $SD = 0.92$).

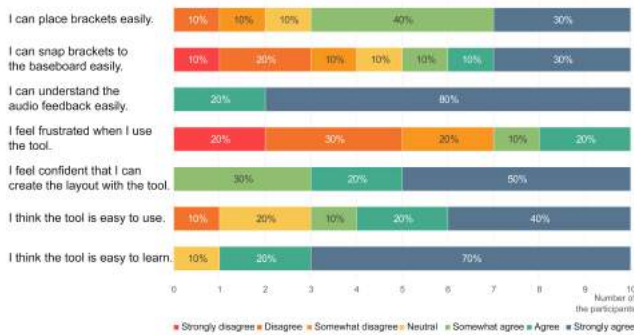

Figure 10: Self-reported ratings of designing a web layout using TangibleGrid.

After the task, several participants talked about the specific layout they created:

...that's a big heading, then some text saying where we are. And then another text and other (image) type. And then the video just a little player. –P5

I think I have a kind of (layout) in my brain about how it looks like. All the way down there was the video, you know, the banner across the top, the two areas (rows), the texts that are six by six, and then the image that's ten by two, and then the video that's two by two. –P9

In terms of the layout building process, we observed that participants had two main strategies when placing the brackets on the baseboard. Some participants preferred to place down one corner of the bracket on the baseboard first and then adjusted the bracket's size (Figure 11a); others preferred to adjust the brackets'



Figure 11: Two main strategies that participants used when placing the brackets on the baseboard.

size off the baseboard first, and then placed the entire bracket on the baseboard all at once (Figure 11b). It is interesting to note that the two different strategies lead to exactly the opposite opinions on the magnet snapping feature ($M = 4.4$, $SD = 2.3$). Participants who preferred the first strategy commented the usefulness of the magnet snapping feature, as it helped to hold one corner of the bracket on the baseboard, and thus they could adjust the bracket size without changing its location.

...the snapping is good. Because it is magnetic, you know, it gets there very fast. –P1

The magnet is strong, but I think it is good, and the magnet helps me...Yeah, I think it would be very difficult without it (magnet) to do it. Magnet helps keep it in place while I am trying to adjust other pieces (corners) of it (bracket). –P5

I think the magnet helps me, it will hold it (the corner of the bracket) in place, so I don't bump it. it's (magnet snapping) probably the best way to do that. –P8

I think I like magnets, yeah, I can see how it works, and maybe more efficient; it's really easy to tell when you have it just right, because they don't move easily. ... I don't want them to weak, so they may just knock over. –P9

For some other participants who preferred the second strategy, the snapping feature might not be very helpful. It could be too strong for them to adjust the bracket size freely, especially when the four corners of a bracket could not be snapped to the correct location all at once. For example, P4, who extended brackets first and then placed it on the baseboard, stated that the magnet force made him think consciously about it, and he could not adjust the size of the bracket after he placed it on the baseboard.

I was confused. How far should I keep it (magnet) from the board to avoid the magnets? If I would hold it up too high then I couldn't count out, but if I would hold it down, then it was all the way around. And then I have to use exert force to detach the magnets again. –P4

The somewhat divided frustration rating ($M = 3.1$, $SD = 1.9$) could also reflect these two opposite opinions. We found the frustration rating was highly relevant to the users' perception of the magnet snapping method. Participants (e.g., P1, P5, P7, P8) who found the magnets useful (strongly agree/agree on "I can snap brackets to the baseboard easily") rated low in frustration (strongly disagree/disagree on "I feel frustrated when I use the tool"). Participants (e.g., P3, P4, P10) who commented that the magnets were too strong reported high frustration.

When placing brackets onto the baseboard, mistakes happen inevitably. During the task, we observed that blind participants were able to correct mistakes by following the grooves on the baseboard. As one example, a bracket corner could sometimes be misaligned, where it was placed on the baseboard one row above or below where it should be. This would make the TangibleGrid system not recognizing the bracket. Following the baseboard grooves and the bracket linkage, participants were able to find that these two lines were not in parallel. They could then correct the mistake by re-positioning the bracket corner to the right place.

Finally, audio feedback of our system was sufficient and also effective ($Ave = 6.8$, $SD = 0.42$). It could help participants confirm the bracket placement, reducing their workload. Most participants stated that they could understand the audio content clearly. However, the speed of the audio feedback could be too fast for P9.

6 DISCUSSION AND FUTURE WORK

6.1 Customization

While the result of the user study confirmed that, despite their prior knowledge, TangibleGrid could effectively support blind users to understand and design the layout of a web page, it is crucial to consider the individual differences and preferences among users and build features with greater flexibility.

For example, as discussed in Section 5.3.2, participants may develop their own strategies of placing the brackets. The magnetic snapping feature, which was designed to securely lock the brackets to the baseboard, could also be a source of distraction to some users. One potential improvement we can make is to allow participants to decide on the strength of the snapping feature. This can be achieved by replacing the current permanent magnets of the baseboard with electromagnets, where the magnetic force can be adjusted.

Similarly, the audio feedback in the current system was limited in that the speed and the information fidelity were pre-defined. Like screen readers, we hope customization can be added to the future software so that participants can decide on their preferred voice-feedback profiles.

6.2 Advanced Layout Design

TangibleGrid set a foundation to support basic web layout design in a tangible manner. Moving forward, we expect future research can expand its functionalities.

For example, Ebrima has tried a smaller size of brackets (15mm X 15mm) in an early exploration, which indicates that the baseboard can have a higher granularity of the grids to support finer brackets placement and adjustment.

The baseboard design can also be improved with higher flexibility. The fixed number of rows may limit a user's creativity, e.g., if a

user hopes to build a long scroll page across multiple screen assets. One possible solution is to modularize the baseboard design, where multiple baseboards can be daisy-chained together. The users will be free from the baseboard size limitation and simply add more baseboards when the design space runs out.

Finally, we expect the tangible approach may support modern web design features, such as responsive web page layout. For example, by adopting the electromagnets as discussed in Section 6.1, it is possible to design an active tangible baseboard where brackets can be relocated automatically, similar to FluxMarker [61]. Such a system will also have a tighter integration to its digital web page representation, as layout changes in the software can be directly reflected with the active baseboard. Of course, how to control the motion of the automated tangibles reliably needs further investigation.

6.3 Supporting Content Design and Editing

During our exit interview, several participants expressed the desire to create web content with TangibleGrid. For example, P7 said, "I'm definitely interested in consuming more of this. Eventually, I want to put some music (on the web page)...". P2 also added, "...it would be nicer to add color (to it) ... that would make it interesting".

Indeed, while the current focus of TangibleGrid is on web layout design, it is only one part of the web design challenges. We consider two possible future directions where content input and editing can also be combined with TangibleGrid.

First, content input and editing can be directly integrated to TangibleGrid as core features. For example, once the user places a text bracket on the baseboard, they can put information directly to it, by long-pressing the top of the bracket and speak to a microphone. Using speech recognition, the voice can be converted to the written content. An image can be inserted in a similar way by matching the user's description to an image from a search engine. For this approach to work, the future tangible brackets need to have touch sensing capabilities on its top. An integrated microphone should also be placed to the baseboard.

The second approach is to combine TangibleGrid with existing web design platforms or programming IDEs, such as WordPress and Pycharm. For example, it is possible to develop a WordPress plugin, where the layout generated from TangibleGrid can be directly exported to the platform. From this layout, screen readers can recognize the auto-generated space holders. WordPress users can then input the web page content and change their properties such as color and font types. Experienced users can directly program the properties of the web elements with HTML and CSS, with the layout taken care of by TangibleGrid.

6.4 Beyond Web Page Layout Design

As discussed in recent work such as [48, 53], visual semantics can be critical for collaboration, navigation, and design. Yet, they are inaccessible to blind users in many scenarios and applications. While TangibleGrid focuses on the layout exploration of a web page, it can potentially be extended for other graphical based tools, such as Microsoft PowerPoint, Apple Keynote, and Google Slides. For example, when the baseboard is placed in a landscape manner, it is possible to simulate the presentation slides, with the text and

image brackets used to align the digital content graphically. Note that for these tools, the digital canvas is usually rendered free-form. Thus, the grid-based mechanism may limit the resolution of the design. Whether and how TangibleGrid can be extended to support grid-free creation remains an open question for future research.

7 CONCLUSION

In this paper, we described the design and development of TangibleGrid, a novel tangible device that allows blind users to understand and design a web page layout independently. Our design was informed by an initial interview with six blind participants and three rounds of co-design sessions that involved multiple iterations of tangible probes and prototypes. Our final system used a magnetic baseboard to represent an HTML canvas and a set of shape-changing brackets to represent three types of web elements. Placing these tangible brackets on the baseboard would activate an audio description of their information, and create the corresponding web page. In the user study, all participants could use TangibleGrid to understand an existing web page layout, and design one from scratch. We hope TangibleGrid can enable blind users to share their creativity in the future.

ACKNOWLEDGMENTS

This work was supported in part by the New Direction Fund from the Maryland Catalyst Fund. We thank Anup Sathya and Biswaksen Patnaik for their feedback. We thank the anonymous reviewers for their valuable comments.

REFERENCES

- [1] William C Adams et al. 2015. Conducting semi-structured interviews. *Handbook of practical program evaluation* 4 (2015), 492–505.
- [2] Khaled Albusays and Stephanie Ludi. 2016. Eliciting Programming Challenges Faced by Developers with Visual Impairments: Exploratory Study. In *Proceedings of the 9th International Workshop on Cooperative and Human Aspects of Software Engineering* (Austin, Texas) (CHASE '16). Association for Computing Machinery, New York, NY, USA, 82–85. <https://doi.org/10.1145/2897586.2897616>
- [3] Khaled Albusays, Stephanie Ludi, and Matt Huenerfauth. 2017. Interviews and Observation of Blind Software Developers at Work to Understand Code Navigation Challenges. In *Proceedings of the 19th International ACM SIGACCESS Conference on Computers and Accessibility* (Baltimore, Maryland, USA) (ASSETS '17). Association for Computing Machinery, New York, NY, USA, 91–100. <https://doi.org/10.1145/3132525.3132550>
- [4] Brent Gillespie Alex Russomanno, Sile O'Modhrain. 2018. *Holy Braille Project*. <https://www.newhaptics.com/holy-braille-project> Accessed on 08.15.2021.
- [5] Mauro Avila, Francisco Kiss, Ismael Rodriguez, Albrecht Schmidt, and Tonja Machulla. 2018. Tactile sheets: using engraved paper overlays to facilitate access to a digital document's layout and logical structure. In *Proceedings of the 11th PErvasive Technologies Related to Assistive Environments Conference*. 165–169.
- [6] Catherine M Baker, Lauren R Milne, and Richard E Ladner. 2015. Structjumper: A tool to help blind programmers navigate and understand the structure of code. In *Proceedings of the 33rd Annual ACM Conference on Human Factors in Computing Systems*. 3043–3052.
- [7] Catherine M Baker, Lauren R Milne, Jeffrey Scofield, Cynthia L Bennett, and Richard E Ladner. 2014. Tactile graphics with a voice: using QR codes to access text in tactile graphics. In *Proceedings of the 16th international ACM SIGACCESS conference on Computers & accessibility*. 75–82.
- [8] Mark S Baldwin, Gillian R Hayes, Oliver L Haimson, Jennifer Mankoff, and Scott E Hudson. 2017. The tangible desktop: a multimodal approach to nonvisual computing. *ACM Transactions on Accessible Computing (TACCESS)* 10, 3 (2017), 1–28.
- [9] Florian Beijers. 2019. *How to Get a Developer Job When You're Blind: Advice From a Blind Developer Who Works Alongside a Sighted Team*. <https://www.freecodecamp.org/news/blind-developer-sighted-team/> Accessed on 03.21.2022.
- [10] Edward C Bell and Natalia M Mino. 2015. Employment outcomes for blind and visually impaired adults. (2015).
- [11] T. Boren and J. Ramey. 2000. Thinking aloud: reconciling theory and practice. *IEEE Transactions on Professional Communication* 43, 3 (2000), 261–278. <https://doi.org/10.1109/47.867942>
- [12] Danielle Bragg, Cynthia Bennett, Katharina Reinecke, and Richard Ladner. 2018. A Large Inclusive Study of Human Listening Rates. In *Proceedings of the 2018 CHI Conference on Human Factors in Computing Systems* (Montreal QC, Canada) (CHI '18). Association for Computing Machinery, New York, NY, USA, 1–12. <https://doi.org/10.1145/3173574.3174018>
- [13] Anke M Brock, Philippe Truillet, Bernard Oriola, Delphine Picard, and Christophe Jouffrais. 2015. Interactivity improves usability of geographic maps for visually impaired people. *Human-Computer Interaction* 30, 2 (2015), 156–194.
- [14] The World Wide Web Consortium. [n. d.]. *Responsive Web Design - Grid-View*. https://www.w3schools.com/css/css_rwd_grid.asp Accessed on 07.14.2022.
- [15] N. Dahlbäck, A. Jönsson, and L. Ahrenberg. 1993. Wizard of Oz studies — why and how. *Knowledge-Based Systems* 6, 4 (1993), 258–266. [https://doi.org/10.1016/0950-7051\(93\)90017-N](https://doi.org/10.1016/0950-7051(93)90017-N) Special Issue: Intelligent User Interfaces.
- [16] Niraj Ramesh Dayama, Simo Santala, Lukas Brückner, Kashyap Todi, Jingzhou Du, and Antti Oulasvirta. 2021. Interactive Layout Transfer. In *26th International Conference on Intelligent User Interfaces*. 70–80.
- [17] Apple Developer. 2022. <https://developer.apple.com/xcode/>
- [18] Dolphin. 2016. *Blogging when you're blind or visually impaired*. <https://yourdolphin.com/news?id=223> Accessed on 08.15.2021.
- [19] Julie Ducasse, Marc JM Macé, Marcos Serrano, and Christophe Jouffrais. 2016. Tangible reels: construction and exploration of tangible maps by visually impaired users. In *Proceedings of the 2016 CHI conference on human factors in computing systems*. 2186–2197.
- [20] Polly Edman. 1992. *Tactile graphics*. American Foundation for the Blind.
- [21] Emma Grey Ellis. 2019. *Meet the Blind YouTubers Making the Internet More Accessible*. <https://www.wired.com/story/blind-youtube-creators/> Accessed on 08.15.2021.
- [22] Cisco Academy for the Vision Impaired. 2022. <https://www.afb.org/aw/17/11/15389>
- [23] The Nation Center for Voice and speech. 2022. <https://ncvs.org/>
- [24] Giovanni Fusco and Valerie S Morash. 2015. The tactile graphics helper: providing audio clarification for tactile graphics using machine vision. In *Proceedings of the 17th International ACM SIGACCESS Conference on Computers & Accessibility*. 97–106.
- [25] Anhong Guo, Jeeun Kim, Xiang'Anthony' Chen, Tom Yeh, Scott E Hudson, Jennifer Mankoff, and Jeffrey P Bigham. 2017. Facade: Auto-generating tactile interfaces to appliances. In *Proceedings of the 2017 CHI Conference on Human Factors in Computing Systems*. 5826–5838.
- [26] Leona Holloway, Kim Marriott, and Matthew Butler. 2018. Accessible maps for the blind: Comparing 3D printed models with tactile graphics. In *Proceedings of the 2018 chi conference on human factors in computing systems*. 1–13.
- [27] Edwin L Hutchins, James D Hollan, and Donald A Norman. 1985. Direct manipulation interfaces. *Human-computer interaction* 1, 4 (1985), 311–338.
- [28] Hiroshi Ishii and Brygg Ullmer. 1997. Tangible Bits: Towards Seamless Interfaces between People, Bits and Atoms. In *Proceedings of the ACM SIGCHI Conference on Human Factors in Computing Systems* (Atlanta, Georgia, USA) (CHI '97). Association for Computing Machinery, New York, NY, USA, 234–241. <https://doi.org/10.1145/258549.258715>
- [29] R Dan Jacobson. 1998. Navigating maps with little or no sight: An audio-tactile approach. In *Content Visualization and Intermedia Representations (CVIR'98)*.
- [30] Shaun K. Kane and Jeffrey P. Bigham. 2014. Tracking @stemxcomet: Teaching Programming to Blind Students via 3D Printing, Crisis Management, and Twitter. In *Proceedings of the 45th ACM Technical Symposium on Computer Science Education* (Atlanta, Georgia, USA) (SIGCSE '14). Association for Computing Machinery, New York, NY, USA, 247–252. <https://doi.org/10.1145/2538862.2538975>
- [31] Shaun K Kane and Jeffrey P Bigham. 2014. Tracking@ stemxcomet: teaching programming to blind students via 3D printing, crisis management, and twitter. In *Proceedings of the 45th ACM technical symposium on Computer science education*. 247–252.
- [32] Claire Kearney-Volpe, Chancey Fleet, Keita Ohshiro, Veronica Alfaro Arias, and Amy Hurst. 2021. Making the Elusive More Tangible: Remote Tools & Techniques for Teaching Web Development to Screen Reader Users. In *Proceedings of the 18th International Web for All Conference* (Ljubljana, Slovenia) (W4A '21). Association for Computing Machinery, New York, NY, USA, Article 9, 14 pages. <https://doi.org/10.1145/3430263.3452418>
- [33] Claire Kearney-Volpe and Amy Hurst. 2021. Accessible Web Development: Opportunities to Improve the Education and Practice of Web Development with a Screen Reader. *ACM Trans. Access. Comput.* 14, 2, Article 8 (jul 2021), 32 pages. <https://doi.org/10.1145/3458024>
- [34] Claire Kearney-Volpe, Amy Hurst, and Scott Fitzgerald. 2019. Blind Web Development Training at Oysters and Pearls Technology Camp in Uganda. In *Proceedings of the 16th International Web for All Conference* (San Francisco, CA, USA) (W4A '19). Association for Computing Machinery, New York, NY, USA, Article 18, 10 pages. <https://doi.org/10.1145/3315002.3317562>

- [35] Jeeun Kim and Tom Yeh. 2015. Toward 3D-printed movable tactile pictures for children with visual impairments. In *Proceedings of the 33rd Annual ACM Conference on Human Factors in Computing Systems*. 2815–2824.
- [36] Steven Landau, Michael Russell, Karen Gourgey, Jane N Erin, and Jennifer Cowan. 2003. Use of the talking tactile tablet in mathematics testing. *Journal of Visual Impairment & Blindness* 97, 2 (2003), 85–96.
- [37] Jingyi Li, Son Kim, Joshua A. Miele, Maneesh Agrawala, and Sean Follmer. 2019. *Editing Spatial Layouts through Tactile Templates for People with Visual Impairments*. Association for Computing Machinery, New York, NY, USA, 1–11. <https://doi.org/10.1145/3290605.3300436>
- [38] Saira Mahmood. 2018. *Beauty influencers with disabilities you need to follow right now*. <https://thetempest.co/2018/12/03/style/beauty-influencers-disability/> Accessed on 08.15.2021.
- [39] Thorsten Maucher, Karlheinz Meier, and Johannes Schemmel. 2001. An interactive tactile graphics display. In *Proceedings of the Sixth International Symposium on Signal Processing and its Applications (Cat. No. 01EX467)*, Vol. 1. IEEE, 190–193.
- [40] Nolwenn Maudet, Ghita Jalal, Philip Tchernavskij, Michel Beaudouin-Lafon, and Wendy E. Mackay. 2017. *Beyond Grids: Interactive Graphical Substrates to Structure Digital Layout*. Association for Computing Machinery, New York, NY, USA, 5053–5064. <https://doi.org/10.1145/3025453.3025718>
- [41] David McGookin, Euan Robertson, and Stephen Brewster. 2010. Clutching at straws: using tangible interaction to provide non-visual access to graphs. In *Proceedings of the SIGCHI conference on human factors in computing systems*. 1715–1724.
- [42] Sean Mealin and Emerson Murphy-Hill. 2012. An exploratory study of blind software developers. In *2012 IEEE Symposium on Visual Languages and Human-Centric Computing (VL/HCC)*. IEEE, 71–74.
- [43] Microsoft. 2022. . <https://code.visualstudio.com/>
- [44] Joshua A Miele, Steven Landau, and Deborah Gilden. 2006. Talking TMAP: Automated generation of audio-tactile maps using Smith-Kettlewell's TMAP software. *British Journal of Visual Impairment* 24, 2 (2006), 93–100.
- [45] Peter O'Donovan, Aseem Agarwala, and Aaron Hertzmann. 2015. *DesignScope: Design with Interactive Layout Suggestions*. Association for Computing Machinery, New York, NY, USA, 1221–1224. <https://doi.org/10.1145/2702123.2702149>
- [46] Erica L. Olmsted-Hawala, Elizabeth D. Murphy, Sam Hawala, and Kathleen T. Ashenfelter. 2010. Think-Aloud Protocols: A Comparison of Three Think-Aloud Protocols for Use in Testing Data-Dissemination Web Sites for Usability. (2010), 2381–2390. <https://doi.org/10.1145/1753326.1753685>
- [47] Ayberk Özgür, Wafa Johal, Francesco Mondada, and Pierre Dillenbourg. 2017. Haptic-enabled handheld mobile robots: Design and analysis. In *Proceedings of the 2017 CHI Conference on Human Factors in Computing Systems*. 2449–2461.
- [48] Venkatesh Potluri, Tadashi E. Grindeland, Jon E. Froehlich, and Jennifer Mankoff. 2021. Examining Visual Semantic Understanding in Blind and Low-Vision Technology Users. In *Proceedings of the 2021 CHI Conference on Human Factors in Computing Systems (Yokohama, Japan) (CHI '21)*. Association for Computing Machinery, New York, NY, USA, Article 35, 14 pages. <https://doi.org/10.1145/3411764.3445040>
- [49] Venkatesh Potluri, Liang He, Christine Chen, Jon E. Froehlich, and Jennifer Mankoff. 2019. A Multi-Modal Approach for Blind and Visually Impaired Developers to Edit Webpage Designs. In *The 21st International ACM SIGACCESS Conference on Computers and Accessibility (Pittsburgh, PA, USA) (ASSETS '19)*. Association for Computing Machinery, New York, NY, USA, 612–614. <https://doi.org/10.1145/3308561.3354626>
- [50] Venkatesh Potluri, Priyan Vaithilingam, Suresh Iyengar, Y. Vidya, Manohar Swaminathan, and Gopal Srinivasa. 2018. CodeTalk: Improving Programming Environment Accessibility for Visually Impaired Developers. In *Proceedings of the 2018 CHI Conference on Human Factors in Computing Systems (Montreal QC, Canada) (CHI '18)*. Association for Computing Machinery, New York, NY, USA, 1–11. <https://doi.org/10.1145/3173574.3174192>
- [51] Orbit Research. 1998. *Graphiti - A Breakthrough in Non-Visual Access to All Forms of Graphical Information*. <http://www.orbitresearch.com/product/graphiti/> Accessed on 08.15.2021.
- [52] Armin Ronacher. 2010. *Flask documentation*. <https://flask.palletsprojects.com/en/2.0.x/> Accessed on 08.15.2021.
- [53] Anastasia Schaadhardt, Alexis Hiniker, and Jacob O Wobbrock. 2021. Understanding Blind Screen-Reader Users' Experiences of Digital Artboards. In *Proceedings of the 2021 CHI Conference on Human Factors in Computing Systems*. 1–19.
- [54] Jochen Schneider and Thomas Strothotte. 2000. Constructive exploration of spatial information by blind users. In *Proceedings of the fourth international ACM conference on Assistive technologies*. 188–192.
- [55] Lei Shi, Idan Zelzer, Catherine Feng, and Shiri Azenkot. 2016. Tickers and talker: An accessible labeling toolkit for 3D printed models. In *Proceedings of the 2016 chi conference on human factors in computing systems*. 4896–4907.
- [56] Lei Shi, Yuhang Zhao, and Shiri Azenkot. 2017. Markit and Talkit: a low-barrier toolkit to augment 3D printed models with audio annotations. In *Proceedings of the 30th annual acm symposium on user interface software and technology*. 493–506.
- [57] Alexa F Siu, Eric J Gonzalez, Shenli Yuan, Jason B Ginsberg, and Sean Follmer. 2018. Shapeshift: 2D spatial manipulation and self-actuation of tabletop shape displays for tangible and haptic interaction. In *Proceedings of the 2018 CHI Conference on Human Factors in Computing Systems*. 1–13.
- [58] Alexa F Siu, Son Kim, Joshua A Miele, and Sean Follmer. 2019. shapeCAD: An accessible 3D modelling workflow for the blind and visually-impaired via 2.5 D shape displays. In *The 21st International ACM SIGACCESS Conference on Computers and Accessibility*. 342–354.
- [59] Andreas Stefik, Andrew Haywood, Shahzada Mansoor, Brock Dunda, and Daniel Garcia. 2009. SODBeans. In *2009 IEEE 17th International Conference on Program Comprehension*. 293–294. <https://doi.org/10.1109/ICPC.2009.5090064>
- [60] Andreas Stefik, Richard E. Ladner, William Allee, and Sean Mealin. 2019. Computer Science Principles for Teachers of Blind and Visually Impaired Students. In *Proceedings of the 50th ACM Technical Symposium on Computer Science Education (Minneapolis, MN, USA) (SIGCSE '19)*. Association for Computing Machinery, New York, NY, USA, 766–772. <https://doi.org/10.1145/3287324.3287453>
- [61] Ryo Suzuki, Abigale Stangl, Mark D Gross, and Tom Yeh. 2017. FluxMarker: Enhancing Tactile Graphics with Dynamic Tactile Markers. In *Proceedings of the 19th International ACM SIGACCESS Conference on Computers and Accessibility*. 190–199.
- [62] Andrew F Tatham. 1991. The design of tactile maps: theoretical and practical considerations. *Proceedings of international cartographic association: mapping the nations* (1991), 157–166.
- [63] Kashyap Todi, Jussi Jokinen, Kris Luyten, and Antti Oulasvirta. 2018. Familiarisation: Restructuring layouts with visual learning models. In *23rd International Conference on Intelligent User Interfaces*. 547–558.
- [64] Kashyap Todi, Daryl Weir, and Antti Oulasvirta. 2016. Sketchplore: Sketch and Explore with a Layout Optimiser. In *Proceedings of the 2016 ACM Conference on Designing Interactive Systems (Brisbane, QLD, Australia) (DIS '16)*. Association for Computing Machinery, New York, NY, USA, 543–555. <https://doi.org/10.1145/2901790.2901817>
- [65] Thorsten Völkel, Gerhard Weber, and Ulrich Baumann. 2008. Tactile graphics revised: the novel brailleis 9000 pin-matrix device with multitouch input. In *International conference on computers for handicapped persons*. Springer, 835–842.
- [66] Wai Yu, Ramesh Ramlooll, and Stephen Brewster. 2000. Haptic graphs for blind computer users. In *International workshop on haptic human-computer interaction*. Springer, 41–51.